

reventon
INDUSTRIAL SOLUTIONS

Technical datasheet

DUCT FAN FR-DF SERIES



- 1. INTRODUCTION
 - 1.1 GENERAL INFORMATION
 - 1.2 STORAGE AND TRANSPORT
 - 1.3 PACKAGE CONTENT
 - 1.4 APPLICATION
- 2. DEVICE CHARACTERISTIC
 - 2.1 CONSTRUCTION AND PRINCIPLE OF OPERATION
 - 2.2 DIMENSIONS
 - 2.3 TECHNICAL DATA
 - 2.4 WORKING CHARACTERISTICS
- 3. ASSEMBLY
 - 3.1 GENERAL PRINCIPLES
- 4. INSTALLATION
 - 4.1 CONNECTION TO VENTILATION SYSTEM
 - 4.2 CONNECTION TO ELECTRICAL INSTALLATION
- 5. EXPLOITATION
 - 5.1 EXPLOITATION PRINCIPLES
- 6. CONTROLS
- 7. WIRING DIAGRAMS
- 8. WARRANTY TERMS

1. INTRODUCTION

Thank you very much for purchasing the duct fan FR-DF series. Please read and keep this manual for future reference of users and operators.

1.1 GENERAL INFORMATION

The owner and the user of unit Reventon brand should read carefully this documentation and follow included guidelines. In case of any doubts regarding the content, please reach out directly to the importer of device i. e. the company Reventon Group Sp. z o. o. [Ltd.]. The contact data are given at the section 8 (subsection XVII).

 The key recommendations from safety point of view are marked with the warning triangle (like the one on the left). It enables quick and easy localization of these recommendations and remind of them before interference with the unit. For the same reason, the requirements for periodic inspection and maintenance of the device, are marked with the wrench symbol (like the one on the left).

 During installation, usage or maintenance of the unit, all local safety requirements must be respected.

The owner and each user of unit must be familiar with the Warranty Terms included in the section 8 of this instruction and follow its guidelines. In case of any doubts regarding warranty points, please reach out immediately to the company Reventon Group Sp. z o. o. [Ltd.] before taking any action.

This documentation was developed by the company Reventon Group Sp. z o. o. [Ltd.] - all rights reserved.

The company Reventon Group Sp. z o. o. [Ltd.] reserves the rights to make changes in the technical documentation without previous notice of the user.

1.2 STORAGE AND TRANSPORT

The fan must be stored and transported on an appropriate pallet, in ambient temperature ranging from -30°C to 60°C and relative humidity ≤ 90%.

During collection of the unit, please check the device exactly to exclude any transport damages. If any is observed, the damage report in presence of the product deliverer must be filled. Such report is the basement for the warranty claim. The damage report must be provided by the product deliverer.

1.3 PACKAGE CONTENT

- duct fan FR-DF
- technical documentation including Warranty Card

1.4 APPLICATION

The duct fan FR-DF series is used in duct ventilation systems of buildings like stores, production and storage halls or workshops. The device cannot be however used in contaminated environments with air containing flammable or explosive substances, chemicals, sticky substances, fibrous materials or soot and oil particles. The duct fan cannot be also used in places, where it would be exposed to too high humid (relative humidity higher than 90%) or direct contact with water or dust, exceeding the permissible contact due to the protection degree IP.

2. DEVICE CHARACTERISTIC

2.1 CONSTRUCTION AND PRINCIPLE OF OPERATION

Housing: made of galvanised steel. It directs the air in a way that ensures axial flow (the airflow direction is shown by the arrow in point 2.2). The integrated mounting bracket allows to assembly the to a building partition, and the connectors enable direct connection of the device to ventilation ducts (the diameter of the connectors - see subsection 2.2, dimension Øf).

Centrifugal fan: fan impeller is made of plastic (FR-100-DF, FR-125-DF, FR-150-DF, FR-160-DF) or galvanised steel (FR-200-DF, FR-250-DF, FR-315-DF). The centrifugal fan provides much higher compression compared to an analogous axial fan. For this reason, it is used in duct ventilation systems. Axial airflow is provided by the housing. The fan has a single-phase motor with IP 44 protection.

2.2 DIMENSIONS

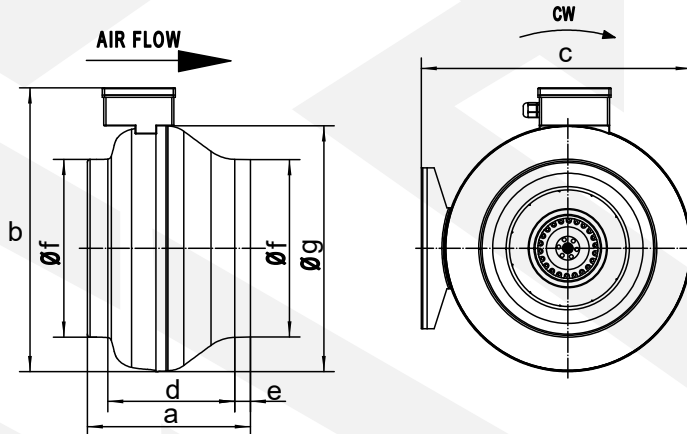

MODEL	FR-100-DF	FR-125-DF	FR-150-DF	FR-160-DF	FR-200-DF	FR-250-DF	FR-315-DF
a	188	188	220	220	227	235	255
b	295±2	295±2	397±2	397±2	400±2	399±2	453±2
c	276±2	276±2	378±2	378±2	380±2	380±2	434±2
d	148±2	152±2	176±2	172±2	176±2	175±2	185±2
e	20	18	23	24	24	30	40
Øf	100±3	125±3	150±3	160±3	200±3	250±3	315±3
Øg	242±2	242±2	344±2	344±2	346±2	346±2	400±2

2.3 TECHNICAL DATA

MODEL Product code	FR-100-DF IDFR100DF-1741	FR-125-DF IDFR125DF-1742	FR-150-DF IDFR150DF-1743	FR-160-DF IDFR160DF-1744	FR-200-DF IDFR200DF-1745	FR-250-DF IDFR250DF-1746	FR-315-DF IDFR315DF-1747
Maximal airflow [m ³ /h]	250	310	590	680	960	1050	1450
Voltage [V] / Frequency [Hz]	230 / 50	230 / 50	230 / 50	230 / 50	230 / 50	230 / 50	230 / 50
Nominal motor current [A]	0.30	0.30	0.43	0.44	0.69	0.68	0.96
Nominal motor power [W]	65	65	95	96	145	140	205
Nominal motor speed [rpm]	2600	2600	2500	2500	2480	2600	2550
IP protection rating of motor [-]	44	44	44	44	44	44	44
Insulation class [-]	F	F	F	F	F	F	F
Net weight [kg]	2.82	2.82	4.30	4.31	5.18	5.23	6.64
Noise [dB(A)]*	63	65	64	65	64	66	70

* the measurement at the distance of 1 m from the device

2.4 WORKING CHARACTERISTICS

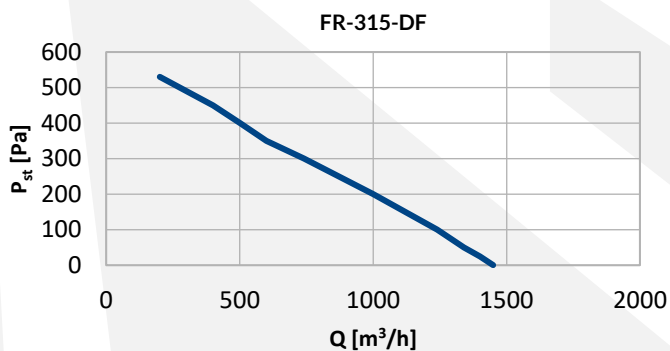
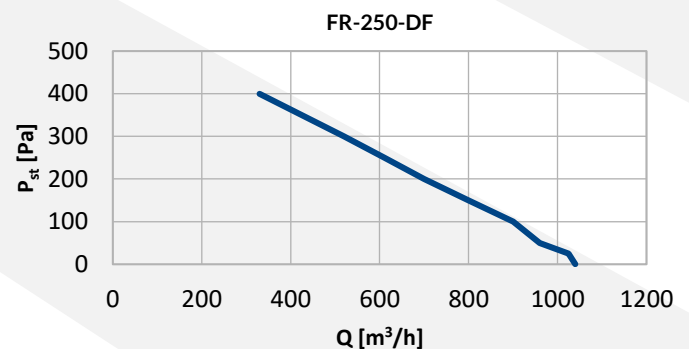
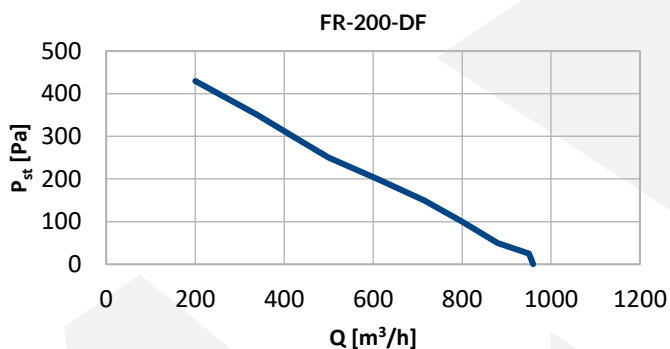
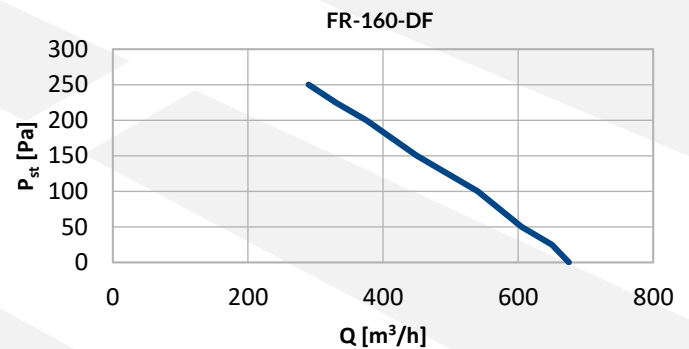
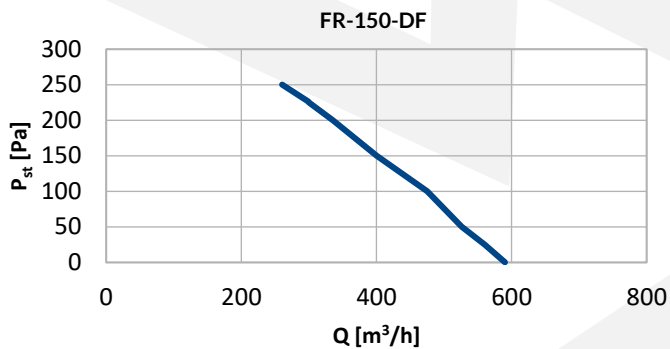
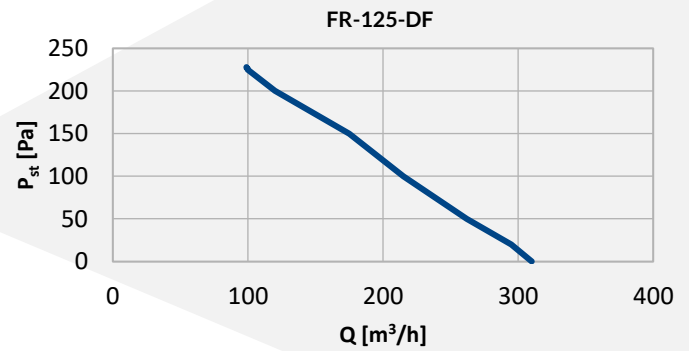
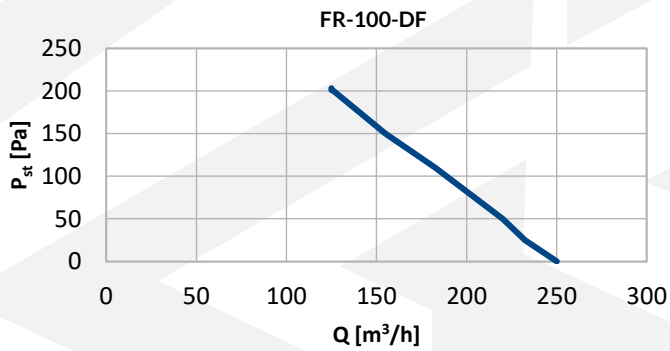

3 ASSEMBLY

3.1 GENERAL PRINCIPLES

 The duct fan should be assembled by people experienced in mounting of such devices and - if local law requires it - with appropriate qualifications.

 It is the responsibility of the assemblers to make the mounting according to the guidelines from this instruction and in accordance with the local regulations in force.

After mounting of the device, the assembler is obliged to fill out the Warranty Card (positions 1 and 2). It is also treated as a guarantee, that the assembly was made in accordance with the requirements. The Warranty Card is included in this manual under the Warranty Terms.

 During mounting, the direction of air flow through the fan must be considered (see the arrow in subsection 2.2).

 The duct fan should be assembled to a building partition using the mounting bracket (integrated with the housing) or mounting clamps.

 The duct fan must be mounted using elements with a load capacity appropriate to its weight.

4. INSTALLATION

 Before connecting the unit to a ventilation and an electrical installation, it must be assembled permanently to a suitable partition (according to the recommendations contained in the section 3).

 All installation, repairs and disassembly works, must be performed by qualified persons i. e. having the appropriate qualifications for these works. It is the responsibility of the installer to make the installation according to the guidelines from this instruction and in accordance with the local regulations in force.

After connecting to the ventilation or electric installations, the installer is obliged to make an entry in the Warranty Card, confirmed by a stamp and signature (positions 3 and 4). It is also treated as a guarantee, that the installation was made in accordance with the requirements of this point 4. The Warranty Card is included in this manual under the Warranty Terms in the section 8.

4.1 CONNECTION TO VENTILATION SYSTEM

 The ventilation installation must be carried out in accordance with the state of the art and the local regulations in force.

 During connection to ventilation system, the direction of air flow through the fan must be considered (see the arrow in subsection 2.2).

The device should be connected with connectors to appropriate ventilation ducts (see Øf dimension in point 2.2).

The connection of connectors with ventilation ducts should be sealed with a ventilation sealing tape.

4.2 CONNECTION TO ELECTRICAL INSTALLATION

 The electrical installation must be carried out in accordance with the state of the art and the local regulations in force.

 The electrical connection to an installation with the electrical parameters according to the section 2.3 should be made in according to the appropriate connection diagram (see section 7).

 As the power cable, it is recommended to use a three-core cable with a 1.5 mm² cross-section with earthing.

 The electrical circuit to which the device is connected, should include all safety element required by the law and the ON/OFF switch enabling safe disconnection of the duct fan from the electrical system. These elements are indicated overall as no. 2 on the connection diagrams in the section 7.

 Before the start up, it is required to check the electrical installation in terms of damaged insulation, incorrect connection in the terminals, risk of potential short circuits etc.

5. EXPLOITATION

5.1 EXPLOITATION PRINCIPLES

 The user is obliged to be familiar with this instruction before exploitation of the device.

 Before any interference in the device, the electricity supply to the duct fan must be absolutely cut off.

 Access to the device by parties like unauthorised people, children and animals is forbidden and should be prevented or at least hindered.

 The device cannot work with covered or restricted air inlet or outlet (e. g. as a result of not keeping the minimum distances from partitions or obstructed inlet/outlet).

 The unit is designed for handling of air at temperature ranging from -30°C to 60°C and with relative humidity ≤ 90%.

 In case of any malfunctions (like blow a fuse, unusual noise etc.), immediately cut off the device from the electrical system and contact directly with the installer, the importer or the distributor. It is forbidden to turn on the unit before diagnosing and removing the reason of this malfunction.

 If the device is not used for a longer time, disconnect the unit from the electrical installation.

 Periodical inspection and maintenance of the device according to the guidelines below, should be carried out at least once a year and always after two-weeks or a longer period of inactivity.

 Before starting any maintenance work, the duct fan must be disconnected from the power supply.

 At the periodic inspection and maintenance, the following should be successively done:

- check the condition of the wiring for its damage and remove/repair any damage
- clean the fan and its housing from residue with a soft cloth
- connect the device to the power supply and assess if the fan works correctly at each stage; additional murmur, metallic reverberation, grinding noise, vibration etc. says about a malfunction - in such case, immediately cut off the device from the electrical system and contact directly with the installer, the importer or the distributor

 Inspection and maintenance of the duct fan should be carried out by a user who is familiar with this instruction or by an external entity if due to the way of assembly or local regulations additional authorisations like e. g. working with electricity or at heights are required.

 The frequency of the service should depend on the actual dirtiness - if the device is operating in an environment with a high concentration of dust, periodic cleaning should be performed much more often.

After exploitation time, please utilise the unit according to the local regulations.

6. CONTROLS

Using of control dedicated to FR-DF gives vast possibilities of adjusting the efficiency of the unit in different degree of automation, depending on the needs.

PROGRAMMABLE CONTROLLER HMI SINGLE

The controller is used to regulate devices equipped with 1-stage fans. It is an advanced controller with many functions i. a. operation in heating, cooling or mixed mode, programmable mode, valve control, automatic selection of the fan speed. Together with the controller the external sensor is provided, which allows to read the temperature in the required place, even remote from the controller. In addition, the device can operate in one of two modes - thermostatic or temperature difference. The second one enables effective controlling of destratification fans. The controller can be integrated with the BMS building control system (using the MODBUS communication protocol).

Voltage / Frequency: 230 V AC / 50 - 60 Hz
Maximum current load: 5 A
Operating temperature range: 0 - 45°C
Regulation range: 5°C - 35°C
Regulation accuracy: 0,5°C
External temperature sensor: NTC 10K
Communication (BMS): RS485
Dimensions: 86 x 86 x 13,3 mm
Weight: 0,27 kg
Degree of protection (housing): IP 20
Degree of protection (external sensor): IP 68

FAN SPEED CONTROLLER HC

The controller is designed to change the single-phase fan's speed by changing the supply voltage. The item has the 5-level knob which enables to change the supply voltage - level 1 represents the lowest voltage while level 5 represents the nominal voltage (i. e. 230 V). The levels 2-4 represents the intermediate vales of voltages. The selection of the appropriate model depends on the number of the devices that will be connected to the to one regulator - the total intensity of the connected devices cannot exceed the maximum current flow of the regulator.

Voltage / Frequency: 230 V AC / 50 - 60 Hz
Maximum current load (depending on model):
1,2 A, 3 A, 5 A, 7 A or 14 A
Protection: thermal switch
Weight (depending on model):
1,45 kg, 2,5 kg, 4,5 kg, 5,5 kg or 10,5 kg
Degree of protection (housing): IP 54



THYRISTOR SPEED CONTROLLER TRO

The controller enables reduction of rotational speed by lowering the supply voltage for a single phase motor by the phase cutting method. It is available in two variants - for motors with a power below 150 W, TRO 150W is recommended, for those with a power between 150 - 600 W, TRO 600W is recommended.



Voltage/Frequency: 220 ~ 240 V / 50 ~ 60 Hz

Maximum load:
150 W for TRO-150W
600 W for TRO-600W

Operating range: $t = -20 - 55^{\circ}\text{C}$, $20\% < \varphi < 90\%$

Housing material: ABS (fireproof)

Dimensions (TRO-150W): 86 x 86 x 42 mm

Dimensions (TRO-600W): 86 x 86 x 40 mm

7. WIRING DIAGRAMS

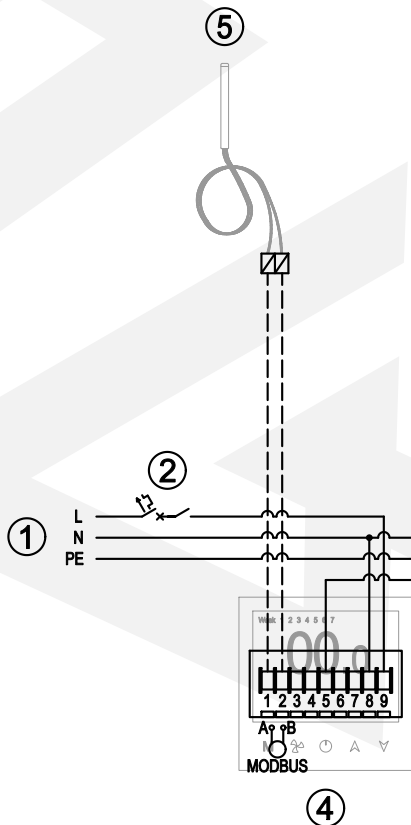

LEGEND

- 1 – voltage supply 230 V/50 Hz
- 2 – protections of the electrical circuit and ON/OFF switch
- 3 – duct fan FR-DF
- 4 – programmable controller HMI SINGLE
- 5 – temperature sensor

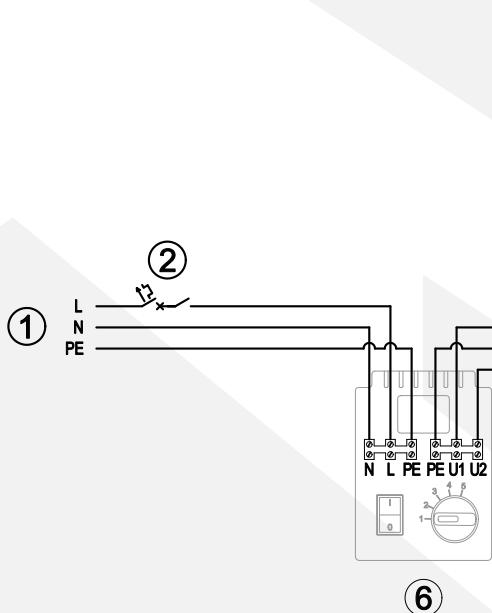

LEGEND

- 1 – voltage supply 230 V/50 Hz
- 2 – protections of the electrical circuit and ON/OFF switch
- 3 – duct fan FR-DF
- 6 – fan speed controller HC

RELAY MODULE RM-16A

The relay enables to control of electricity devices (e. g. fans) which consume higher current that the permissible one for a connected regulator.



Voltage / Frequency: 230 V AC / 50 - 60 Hz

Maximum current load: 16 A

Inputs: dry contact NO/COM and SL voltage

Output: relay NO/COM/NC

Dimensions: 47 x 47 x 20 mm

LEGEND

- 1 – voltage supply 230 V/50 Hz
- 2 – protections of the electrical circuit and ON/OFF switch
- 3 – duct fan FR-DF
- 7 - thyristor speed controller TRO

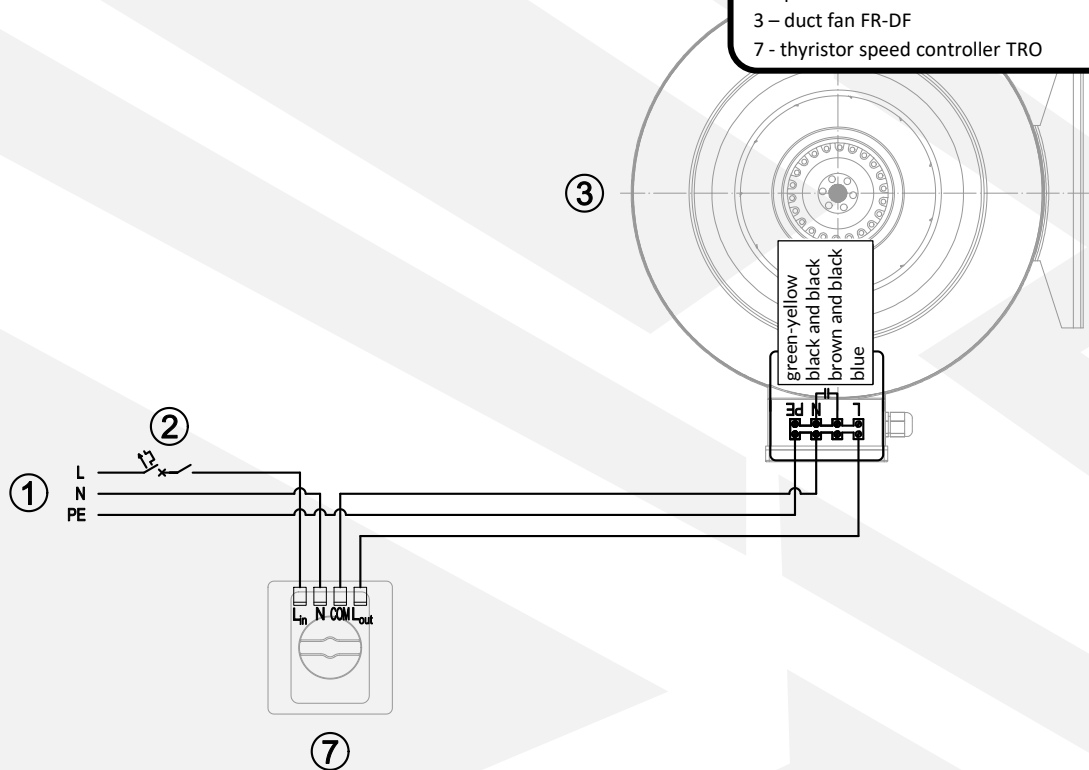

LEGEND

- 1 – voltage supply 230 V/50 Hz
- 2 – protections of the electrical circuit and ON/OFF switch
- 3 – duct fan FR-DF
- 4 – programmable controller HMI SINGLE
- 5 – temperature sensor
- 8 – relay module RM-16A

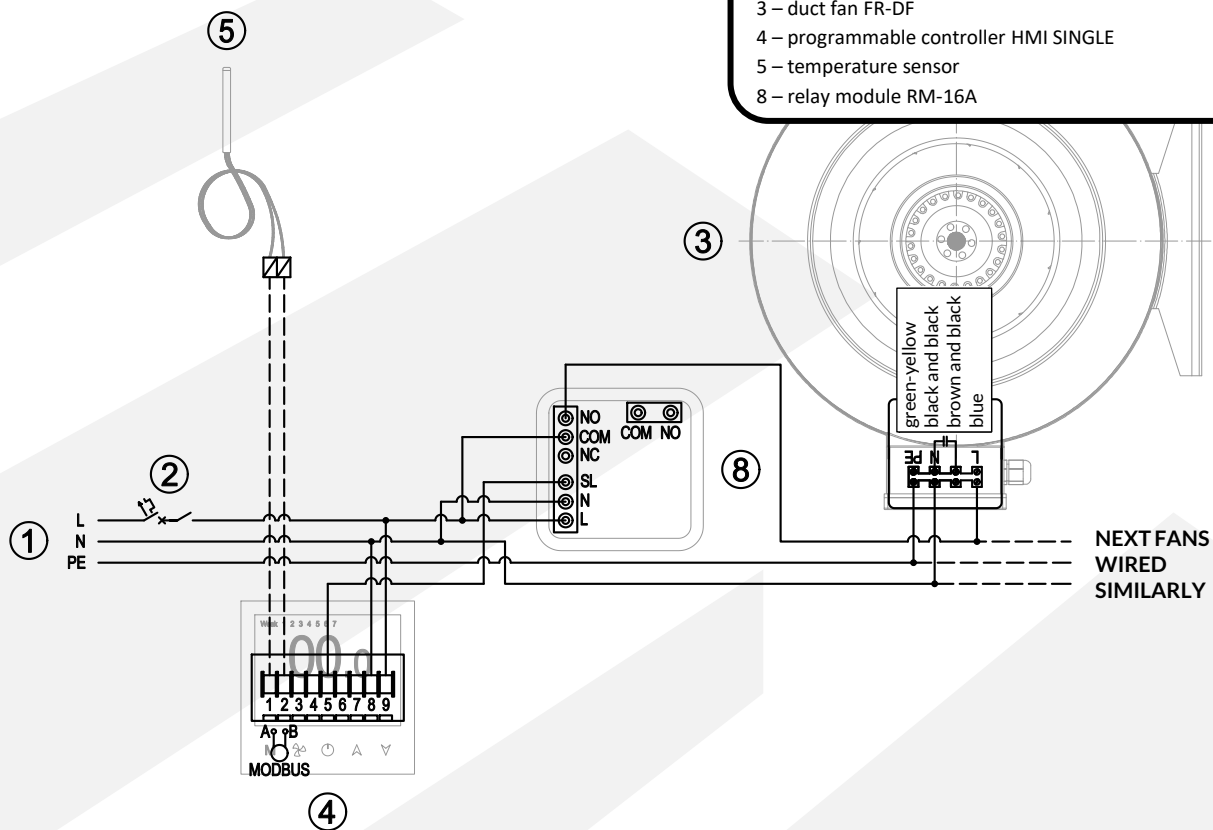

8. WARRANTY TERMS

I. The company Reventon Group Sp. z o. o. [Ltd.], hereinafter referred to as the guarantor, provides 24-month warranty protection period for the following devices:

- duct fan FR-100-DF
- duct fan FR-125-DF
- duct fan FR-150-DF
- duct fan FR-160-DF
- duct fan FR-200-DF
- duct fan FR-250-DF
- duct fan FR-315-DF

II. The warranty protection is valid from the purchasing date by end user (i.e. the issue date of invoice) but not longer than 30 months from leaving the warehouse of Reventon Group Sp. z o. o. [Ltd.].

III. The warranty claim should be reported via the complaint form on the website (<https://reventongroup.eu/en/complaints>). The scan or the photo of the fulfilled Warranty Card and the purchase invoice must be attached to the form. The Warranty Card is not required in case of accessories.

IV. The guarantor is committed to consider the claim within 14 working days since the date of reporting (i. e. the day of receipt of the correctly fulfilled warranty form).

V. In exceptional cases, the guarantor reserves the right to extend the time for consideration of the request, especially if the defect is not permanent one and its determination requires a deeper analysis. The extension must be notified by the guarantor before the end of the 14th working day.

VI. Under the warranty, the guarantor provides a repairment, replacement (the device or its component) or refund for the defective item within a specified time.

VII. In the case of replacement of a device component, the warranty protection of the whole unit is not prolonged.

VIII. The guarantor does not cover the costs of disassembly and eventual reassembly of the complaint device.

IX. The guarantor may decide to bring the defective device or its component to the service of Reventon Group Sp. z o. o. [Ltd.]. In such case the transport of the item is organised and paid by the guarantor. The responsibility of the device's owner is to prepare the item for the shipment - the device must be packed in a way which protects it against transport damages and the dimensions and weight of the package must not exceed 660 x 650 x 400 mm and 30 kg respectively. In the case of elements which cannot be packed in this way, the method of shipment must be agreed and approved by Reventon Group Sp. z o. o. [Ltd.]. In the case of sending a non-standard package without agreement of the service of Reventon Group Sp. z o. o. [Ltd.], the guarantor reserves the right to charge the owner of device with all additional transport costs.

X. In the case of arrival of the authorized service of the guarantor or an installer to fix the complaint item, the customer must ensure them seamless access to the device and all required media like electricity, water, lighting etc. free of charge.

XI. The warranty protection does not cover the parts of the device subject to the normal usage and the following cases:

- a) mechanical damage of the product
- b) defects and damages through:
 - improper storage or transport
 - improper or non-compliant use and maintenance (i. e. inconsistent with the manual)
 - using the device in the improper conditions (too high humidity, too high or too low temperature, impact of the surrounding, sun etc.)
 - unauthorized (i. e. by the user or other unauthorized persons) repairs, modifications or construction changes
 - connecting equipment inconsistent with the technical documentation
 - connecting additional equipment, which is not recommended by the guarantor
 - improper power supply
 - random events (like fire, flood, storm etc.)
- c) elements which wear and tear such as discolour of the housing

If there is any of the above, the claimant will be charged for transport and / or repairs.

XII. During collection of the device, the item must be checked exactly by the receiver to exclude transport damages. If any of them is observed, the damage report in presence of the product deliverer have to be filled - such report is the basement for the warranty claim. The damage report must be provided by the product deliverer.

XIII. The guarantor does not take the responsibility for potential losses and damages related to the downtime of the device during its failure and the complaint considering time.

XIV. Any changes in the Warranty Terms, improper use of the product as well as traces of self repairing (beyond the guarantor service) or alterations cause, the warranty become invalid.

XV. These Warranty Terms do not exclude or limit any rights arising from the pledge.

XVI. Not following to any of the warranty regulations makes the protection invalid.

XVII. All correspondence should be sent to the following address: Reventon Group Sp. z o.o. [Ltd.], 556 Wyzwolenia Street, 43 340 Kozy, Poland or email address: serwis@reventongroup.eu.

Warranty Card

1 - Model and serial number* or product code	2 - Address and place of assembly
3 - Date of connection to:	4 - Stamp and signature of installer:
Heating/cooling installation (if applicable)	
Ventilation installation (if applicable)	
Electrical installation (if applicable)	

* serial number is required only for water heaters HC-3S, HC-EC and FARMER HCF series and recovery units INSPIRO, INSPIRO BASIC and VERTIC series

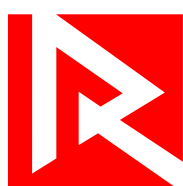

reventon
INDUSTRIAL SOLUTIONS

Reventon Group Sp. z o.o. [Ltd.], 556 Wyzwolenia Street, 43-340 Kozy, Poland, www.reventongroup.eu